

Data Sheet



Article number: 20331332

Description: E+G Handwheel
GN 555-200-B18-D

Measures

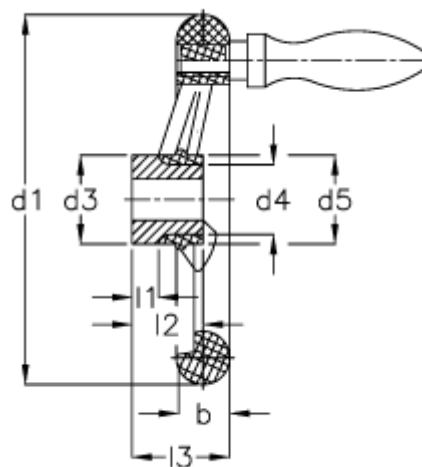
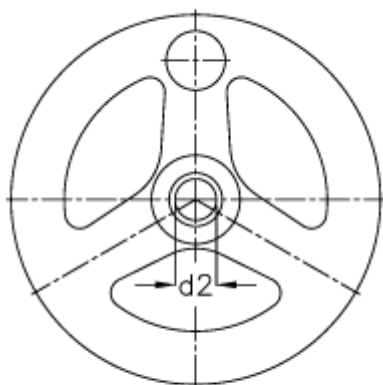

b	= 24	l1 -0.5	= 4
d1	= 200	l2 -0.5	= 32
d2 H7	= 20	l3	= 45
d2 H7	= 18	Number of spokes	= 3
d3	= 40		
d4	= 31		
d5	= 45		
Handle	= 25		